

---

## Zero-Drift, Rail-to-Rail I/O CMOS Operational Amplifiers

---

### Features

- **Low Offset Voltage: 40 $\mu$ V (Maximum)**
- **Input Offset Drift: 0.05 $\mu$ V/ $^{\circ}$ C**
- **High Gain Bandwidth Product: 350KHz**
- **Rail-to-Rail Input and Output**
- **High Gain, CMRR, PSRR:130dB**
- **High Slew Rate: 0.17V/ $\mu$ s**
- **Low Noise: 1.6 $\mu$ Vp-p (0.01~10Hz)**
- **Low Power Consumption: 60 $\mu$ A /op amp**
- **Overload Recovery Time:6 $\mu$ s**
- **Low Supply Voltage: +2.3 V to +5.5 V**
- **No External Capacitors Required**
- **Extended Temperature: -40 $^{\circ}$ C to +125 $^{\circ}$ C**

### Applications

- **Temperature Sensors**
- **Medical/Industrial Instrumentation**
- **Pressure Sensors**
- **Battery-Powered Instrumentation**
- **Active Filtering**
- **Weight Scale Sensor**
- **Strain Gage Amplifiers**
- **Power Converter/Inverter**

### Description

The RS8511, RS8512, RS8514, RS8513(dual version & shutdown) series of CMOS operational amplifiers use auto-zero techniques to simultaneously provide very low offset voltage (40 $\mu$ V max) and near-zero drift over time and temperature. This family of amplifiers has ultralow noise, offset and power.

This miniature, high-precision operational amplifiers offset high input impedance and rail-to-rail input and rail-to-rail output swing. With high gain-bandwidth product of 350KHz and slew rate of 0.17V/ $\mu$ s. Single or dual supplies as low as +2.3V( $\pm$ 1.15V) and up to +5.5V ( $\pm$ 2.75V) may be used.

The RS8511/RS8512/RS8514/RS8513(dual version with shutdown) are specified for the extended industrial and automotive temperature range (-40 $^{\circ}$ C to 125 $^{\circ}$ C). The RS8511 single amplifier is available in 5-lead SOT23, 8-lead MSOP8 and 8-lead SOIC packages, The RS8512 dual amplifier is available in 8-lead SOIC, 8-lead TDFN2x2 and 8-lead TSSOP narrow surface mount packages, The RS8513(dual version with shutdown) comes in *Micro-SIZE* MSOP-10. The RS8514 quad is available in 14-lead SOIC and 14-lead narrow TSSOP packages.

## PIN CONFIGURATIONS

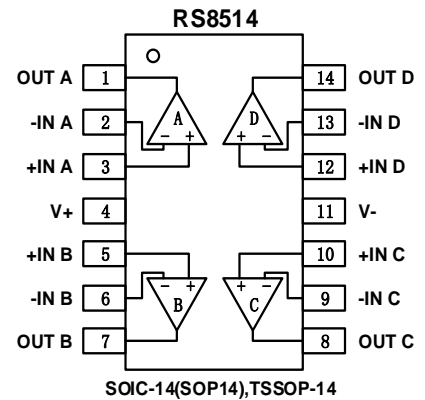
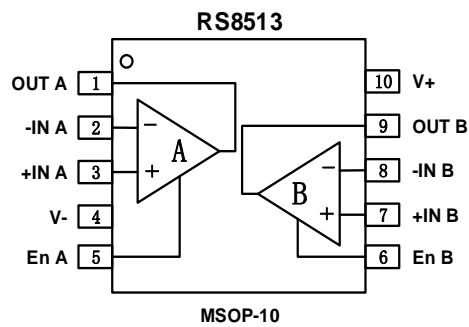
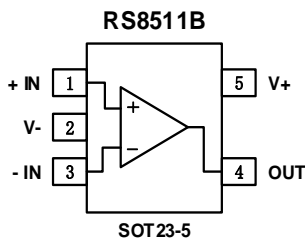
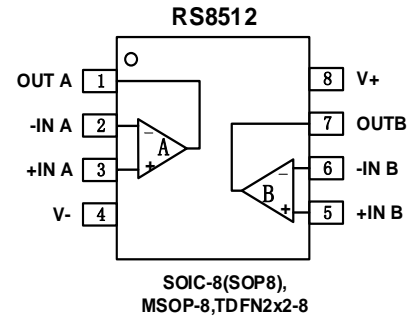
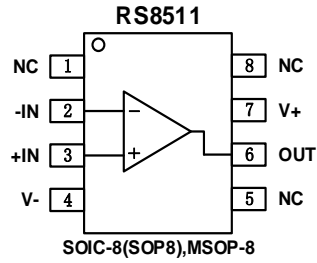
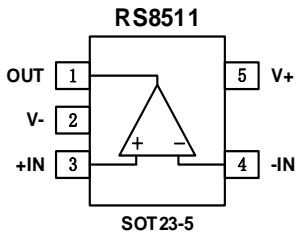

**Note: NC indicates no internal connection**

**ABSOLUTE MAXIMUM RATINGS (1)**

Supply Voltage, V+ to V-.....	7.0V
Input Terminals, Voltage (2) .....	- 0.5 to (V+) + 0.5V
Current (2) .....	±10mA
Storage Temperature .....	-65°C to +150°C
Operating Temperature .....	-40°C to +125°C
Junction Temperature.....	150°C
Package Thermal Resistance @ T <sub>A</sub> = +25°C	
SOT23-5, SOT23-6.....	200°C/W
MSOP-10, SOIC-8 .....	150°C/W
SOIC-14, TSSOP-14.....	100°C/W
Lead Temperature (Soldering, 10s) .....	260°C
ESD Susceptibility	
HBM .....	5000V
MM .....	400V



**ESD SENSITIVITY CAUTION**

ESD damage can range from subtle performance degradation to complete device failure. Precision integrated circuits may be more susceptible to damage because very small parametric changes could cause the device not to meet its published specifications.

- (1) Stresses above these ratings may cause permanent damage. Exposure to absolute maximum conditions for extended periods may degrade device reliability. These are stress ratings only, and functional operation of the device at these or any other conditions beyond those specified is not implied.
- (2) Input terminals are diode-clamped to the power-supply rails. Input signals that can swing more than 0.5V beyond the supply rails should be current-limited to 10mA or less.

**PACKAGE/ORDERING INFORMATION**

PRODUCT	ORDERING NUMBER	TEMPRANGE	PACKAGE	PACKAGE MARKING	TRANSPORT MEDIA, QUANTITY
RS8511	RS8511XF	-40°C ~125°C	SOT23-5	8511	Reel,3000
	RS8511BXF	-40°C ~125°C	SOT23-5	8511B	Reel,3000
	RS8511XK	-40°C ~125°C	SOIC-8(SOP8)	RS8511	Reel,2500
	RS8511XM	-40°C ~125°C	MSOP-8	RS8511	Reel,3000
RS8512	RS8512XK	-40°C ~125°C	SOIC-8(SOP8)	RS8512	Reel,2500
	RS8512XM	-40°C ~125°C	MSOP-8	RS8512	Reel,3000
	RS8512XTDE8	-40°C ~125°C	TDFN-2x2-8	RS8512	Reel,3000
RS8513	RS8513XN	-40°C ~125°C	MSOP-10	RS8513	Reel,3000
RS8514	RS8514XP	-40°C ~125°C	SOIC-14(SOP14)	RS8514	Reel,2500
	RS8514XQ	-40°C ~125°C	TSSOP-14	RS8514	Reel,3000

**ELECTRICAL CHARACTERISTICS**

**Boldface** limits apply over the specified temperature range,  $T_A = -40^{\circ}\text{C}$  to  $+125^{\circ}\text{C}$ .

(At  $T_A = +25^{\circ}\text{C}$ ,  $V_S=5\text{V}$ ,  $R_L = 10\text{k}\Omega$  connected to  $V_S/2$ , and  $V_{\text{OUT}} = V_S/2$ , unless otherwise noted.)

PARAMETER	CONDITION	RS8511, RS8512, RS8513, RS8514			UNIT
		MIN	TYP	MAX	
<b>OFFSET VOLTAGE</b>					
Input Offset Voltage $V_{os}$	$V_{CM} = V_S/2$		7	40	$\mu\text{V}$
<b>VS Temperature</b> $dV_{os}/dT$			<b>0.05</b>	<b>0.2</b>	$\mu\text{V}/^{\circ}\text{C}$
<b>VS Power Supply</b> <b>PSRR</b>	<b>VS = +2.3V to +5.5V, VCM = 0</b>	<b>110</b>	<b>130</b>		<b>dB</b>
Channel Separation, dc			0.1		$\mu\text{V}/\text{V}$
<b>INPUT BIAS CURRENT</b>					
Input Bias Current $I_B$	$V_{CM} = V_S/2$		50		$\text{pA}$
Input Offset Current $I_{os}$			10		$\text{pA}$
<b>NOISE PERFORMANCE</b>					
Input Voltage Noise $e_{n,p-p}$	$f=0.01\text{Hz}$ to $10\text{Hz}$		1.6		$\mu\text{V}_{pp}$
Input Voltage Noise $e_{n,p-p}$	$f=0.01\text{Hz}$ to $1\text{Hz}$		0.48		$\mu\text{V}_{pp}$
Input Voltage Noise Density $e_n$	$f=1\text{KHz}$		70		$\text{nV}/\sqrt{\text{Hz}}$
Input Current Noise Density $i_n$	$f=10\text{Hz}$		8		$\text{fA}/\sqrt{\text{Hz}}$
<b>INPUT VOLTAGE RANGE</b>					
Common-Mode Voltage Range $V_{CM}$		(V-)-0.1		(V+)+0.1	V
<b>Common-Mode Rejection Ratio</b> <b>CMRR</b>	<b>(V-) - 0.1V &lt; V<sub>CM</sub> &lt; (V+)+ 0.1V</b>	<b>110</b>	<b>130</b>		<b>dB</b>
<b>INPUT CAPACITANCE</b>					
Differential			1		$\text{pF}$
Common-Mode			5		$\text{pF}$
<b>OPEN-LOOP GAIN</b>					
<b>Open-Loop Voltage Gain</b> <b>A<sub>OL</sub></b>	<b>RL=10KΩ, VO=0.3V to 4.7V, -40°C~125°C</b>	<b>110</b>	<b>130</b>		<b>dB</b>
<b>DYNAMIC PERFORMANCE</b>					
Slew Rate <b>SR</b>	$G=+1$		0.17		$\text{V}/\mu\text{s}$
Gain-Bandwidth Product <b>GBW</b>			350		$\text{KHz}$
Overload Recovery Time			6		$\mu\text{s}$
<b>OUTPUT CHARACTERISTICS</b>					
Output Voltage High $V_{OH}$	$R_L=100\text{K}\Omega$ to GND	4.99	4.998		V
	$R_L=10\text{K}\Omega$ to GND	4.95	4.98		V
Output Voltage Low $V_{OL}$	$R_L=100\text{K}\Omega$ to V+		1	10	mV
	$R_L=10\text{K}\Omega$ to V+		10	30	mV
Short-Circuit Current $I_{SC}$			25		$\text{mA}$
<b>POWER SUOOLY</b>					
Operating Voltage Range		2.3		5.5	V
Quiescent Current/ Amplifier $I_Q$			60	87	$\mu\text{A}$
<b>SHUTDOWN</b>					
$t_{OFF}$			2		$\mu\text{s}$
$t_{ON}$			1		$\text{ms}$
$V_L$ (shutdown)		0		+0.8	V
$V_H$ (amplifier is active)		0.75(V+)		V+	V
Input Bias Current of Enable Pin			50		$\text{pA}$
$I_{QSD}$			1	5	$\mu\text{A}$

**TYPICAL CHARACTERISTICS**

At  $T_A = +25^\circ\text{C}$ ,  $V_S = 5\text{V}$ ,  $R_L = 10\text{k}\Omega$  connected to  $V_S/2$ ,  $V_{OUT} = V_S/2$ , unless otherwise noted.

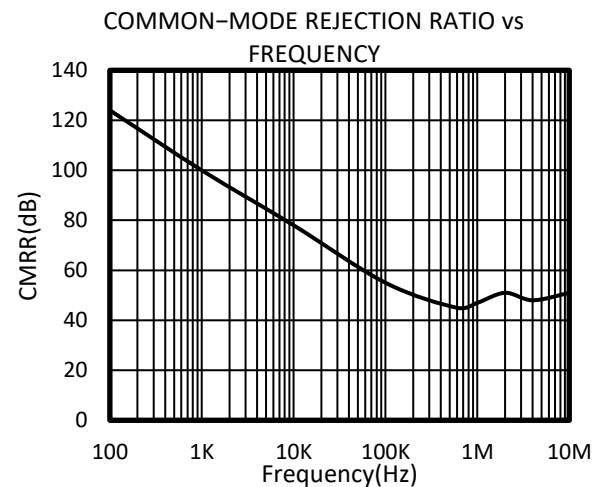
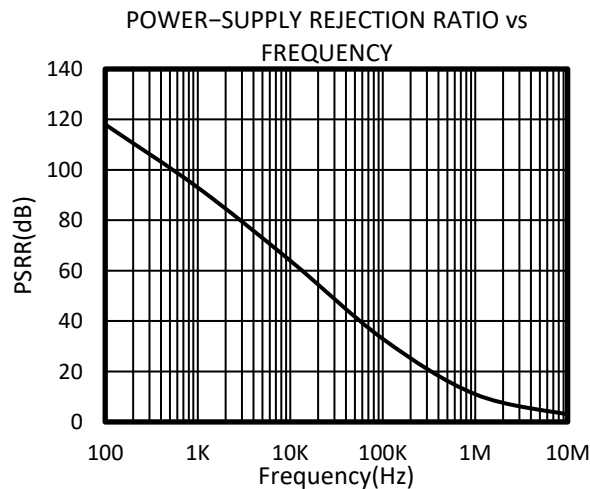
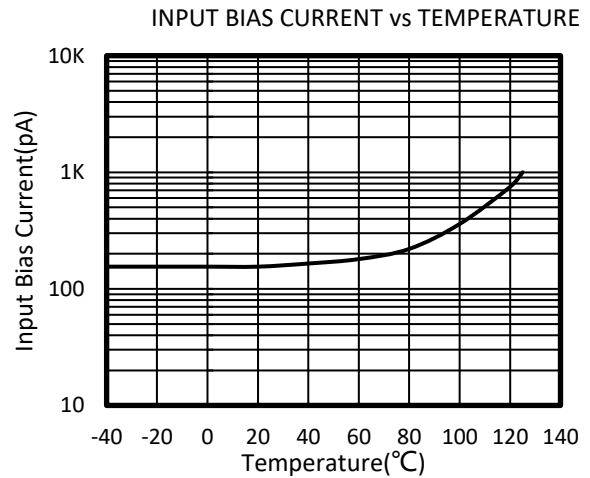
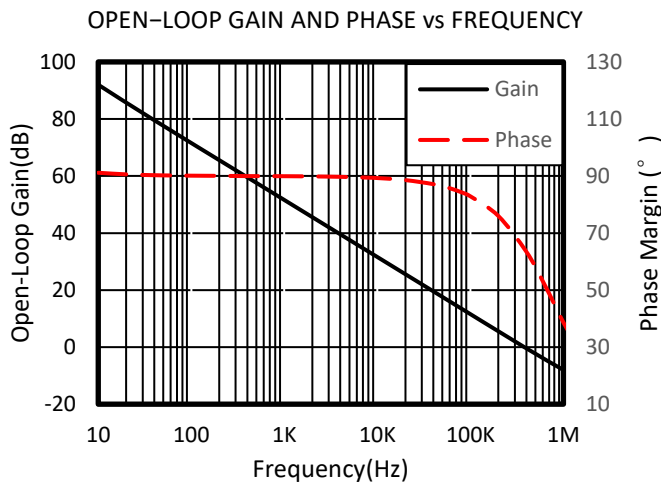
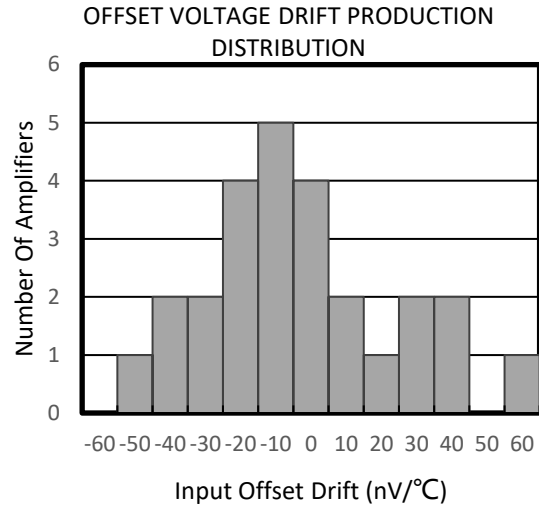
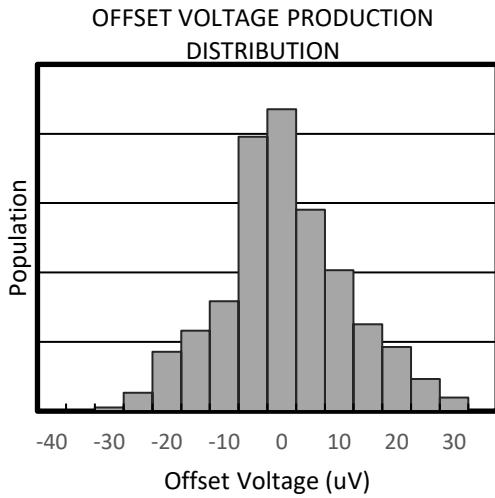

### TYPICAL CHARACTERISTICS

At  $T_A = +25^\circ\text{C}$ ,  $V_S=5\text{V}$ ,  $R_L = 10\text{k}\Omega$  connected to  $V_S/2$ ,  $V_{OUT} = V_S/2$ , unless otherwise noted.

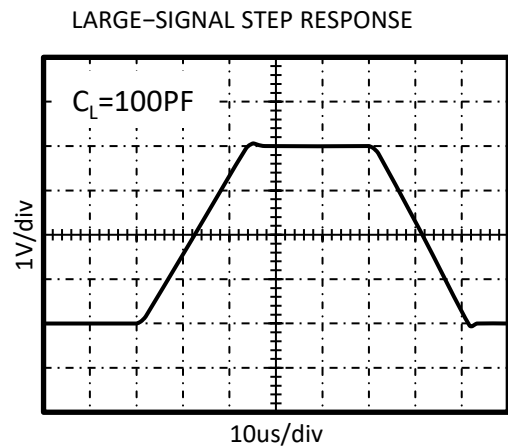
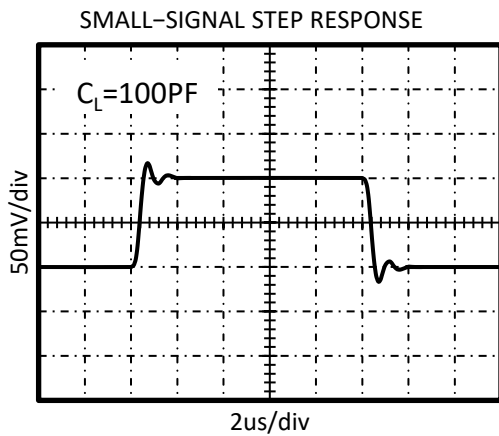
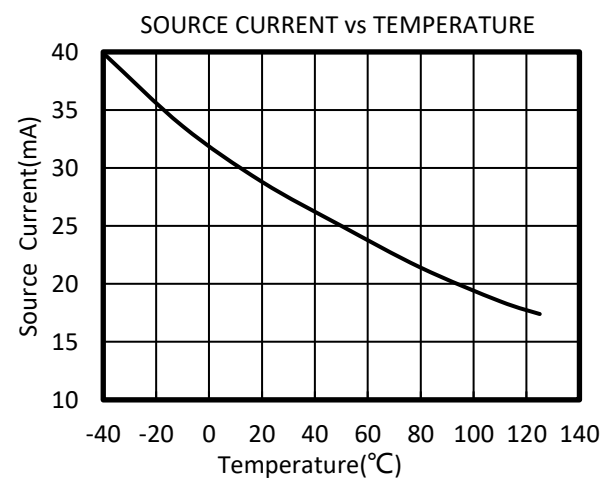
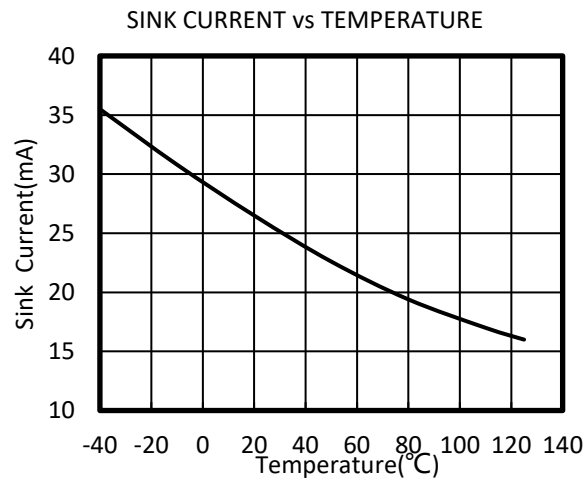
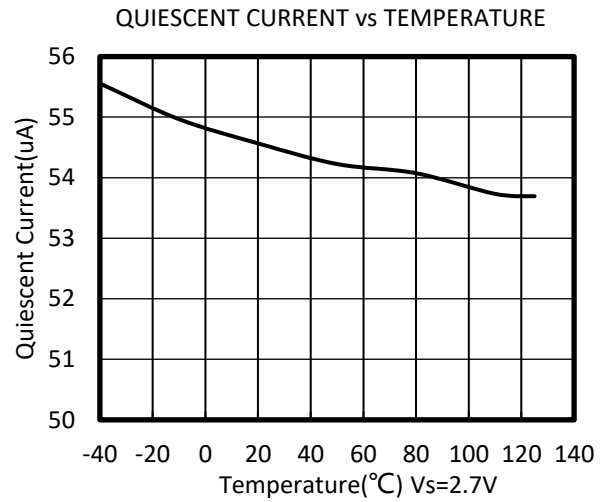
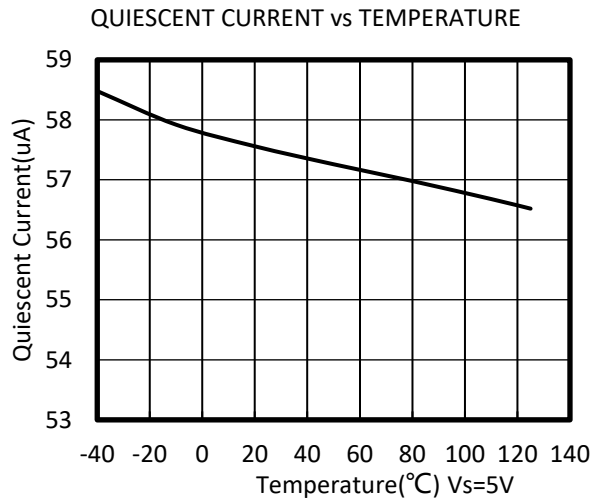

## TYPICAL CHARACTERISTICS

At  $T_A = +25^\circ\text{C}$ ,  $V_S = 5\text{V}$ ,  $R_L = 10\text{k}\Omega$  connected to  $V_S/2$ ,  $V_{OUT} = V_S/2$ , unless otherwise noted.

POSITIVE OVERVOLTAGE RECOVERY

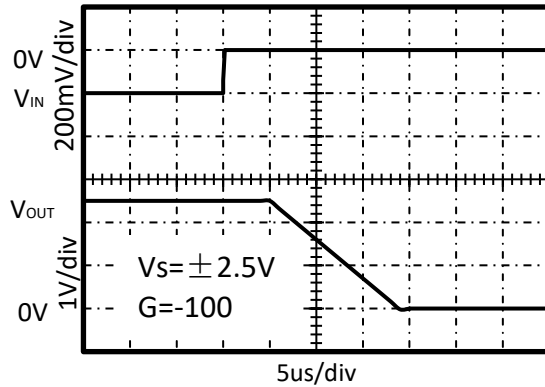

NEGATIVE OVERVOLTAGE RECOVERY

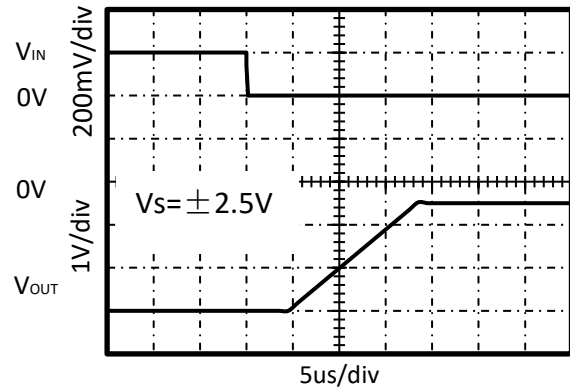

0.01Hz TO 10Hz NOISE AT  $V_S = 5\text{V}$

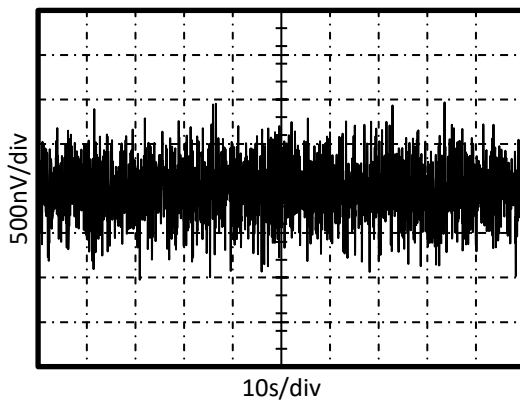

0.01Hz TO 10Hz NOISE AT  $V_S = 2.7\text{V}$

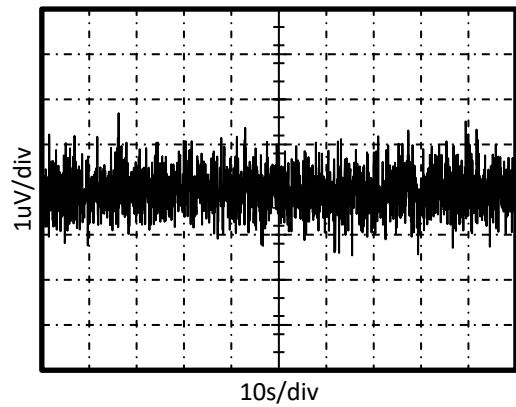

0.01Hz TO 1Hz NOISE AT  $V_S = 5\text{V}$

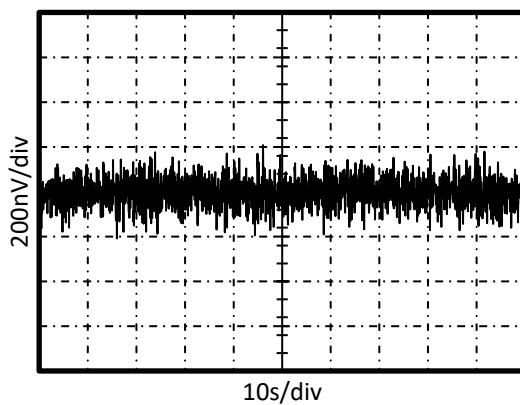

0.01Hz TO 1Hz NOISE AT  $V_S = 2.7\text{V}$

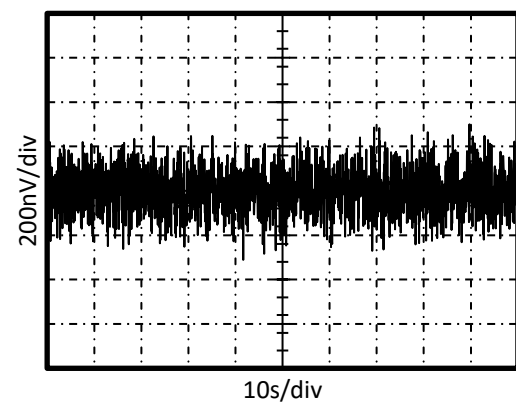

## APPLICATION NOTES

The RS8511, RS8512, RS8513, RS8514 series op amps are unity-gain stable and free from unexpected output phase reversal. They use auto-zeroing techniques to provide low offset voltage and very low drift over time and temperature.

Good layout practice mandates use of a 0.1 $\mu$ F capacitor placed closely across the supply pins.

For lowest offset voltage and precision performance, circuit layout and mechanical conditions should be optimized. Avoid temperature gradients that create thermoelectric (Seebeck) effects in thermocouple junctions formed from connecting dissimilar conductors. These thermally-generated potentials can be made to cancel by assuring that they are equal on both input terminals.

- Use low thermoelectric-coefficient connections (avoid dissimilar metals).
- Thermally isolate components from power supplies or other heat-sources.
- Shield op amp and input circuitry from air currents, such as cooling fans.

Following these guidelines will reduce the likelihood of junctions being at different temperatures, which can cause thermoelectric voltages of 0.1 $\mu$ V/ $^{\circ}$ C or higher, depending on materials used.

### OPERATING VOLTAGE

The RS8511, RS8512, RS8513, RS8514 series op amps operate over a power-supply range of +2.3V to +5.5V ( $\pm$ 1.15V to  $\pm$ 2.75V). Supply voltages higher than 7V (absolute maximum) can permanently damage the amplifier. Parameters that vary over supply voltage or temperature are shown in the Typical Characteristics section of this data sheet.

### RS8513 ENABLE FUNCTION

The enable/shutdown digital input is referenced to the V $_{-}$  supply voltage of the amp. A logic high enables the op amp. A valid logic high is defined as >

75% of the total supply voltage. The valid logic high signal can be up to 5.5V above the negative supply, independent of the positive supply voltage. A valid logic low is defined as < 0.8V above the V $_{-}$  supply pin. If dual or split power supplies are used, be sure that logic input signals are properly referred to the negative supply voltage. The Enable pin must be connected to a valid high or low voltage, or driven, not left open circuit.

The logic input is a high-impedance CMOS input, with separate logic inputs provided on the dual version. For battery operated applications, this feature can be used to greatly reduce the average current and extend battery life.

The enable time includes one full autozero cycle required by the amplifier to return to V $_{OS}$  accuracy. Prior to this time, the amplifier functions properly, but with unspecified offset voltage.

Disable time is 1 $\mu$ s. When disabled, the output assumes a high-impedance state. This allows the RS8513 to be operated as a gated amplifier, or to have the output multiplexed onto a common analog output bus.

### LAYOUT GUIDELINES

Attention to good layout practices is always recommended. Keep traces short. When possible, use a PCB ground plane with surface-mount components placed as close to the device pins as possible. Place a 0.1 $\mu$ F capacitor closely across the supply pins. These guidelines should be applied throughout the analog circuit to improve performance and provide benefits such as reducing the EMI (electromagnetic-interference) susceptibility.

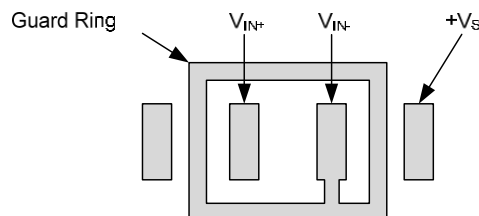
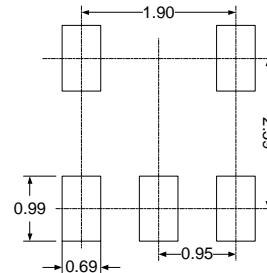
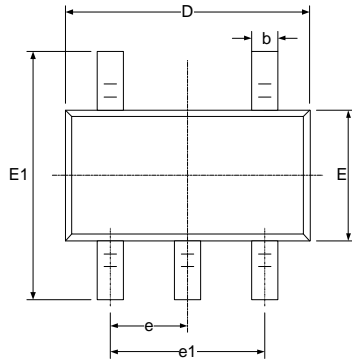

**Figure 1. The Layout of Guard Ring**



# PACKAGE OUTLINE DIMENSIONS

## SOT23-5



RECOMMENDED LAND PATTERN (Unit: mm)

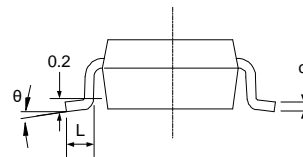
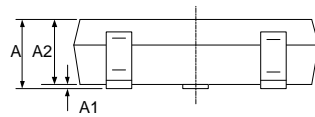

Symbol	Dimensions In Millimeters		Dimensions In Inches	
	Min	Max	Min	Max
A	1.050	1.250	0.041	0.049
A1	0.000	0.100	0.000	0.004
A2	1.050	1.150	0.041	0.045
b	0.300	0.500	0.012	0.020
c	0.100	0.200	0.004	0.008
D	2.820	3.020	0.111	0.119
E	1.500	1.700	0.059	0.067
E1	2.650	2.950	0.104	0.116
e	0.950(BSC)		0.037(BSC)	
e1	1.800	2.000	0.071	0.079
L	0.300	0.600	0.012	0.024
$\theta$	0°	8°	0°	8°

# MSOP-8

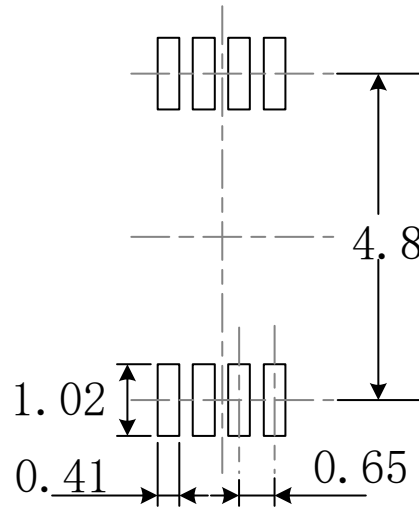
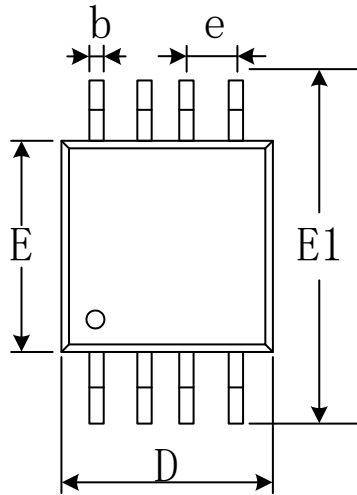

RECOMMENDED LAND PATTERN (Unit: mm)

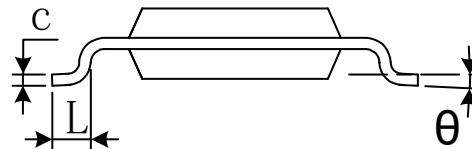
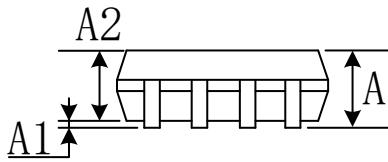

Symbol	Dimensions In Millimeters		Dimensions In Inches	
	Min	Max	Min	Max
A	0.820	1.100	0.032	0.043
A1	0.020	0.150	0.001	0.006
A2	0.750	0.950	0.030	0.037
b	0.250	0.380	0.010	0.015
c	0.090	0.230	0.004	0.009
D	2.900	3.100	0.114	0.122
e	0.650(BSC)		0.026(BSC)	
E	2.900	3.100	0.114	0.122
E1	4.750	5.050	0.187	0.199
L	0.400	0.800	0.016	0.031
$\theta$	0°	6°	0°	6°

# MSOP-10

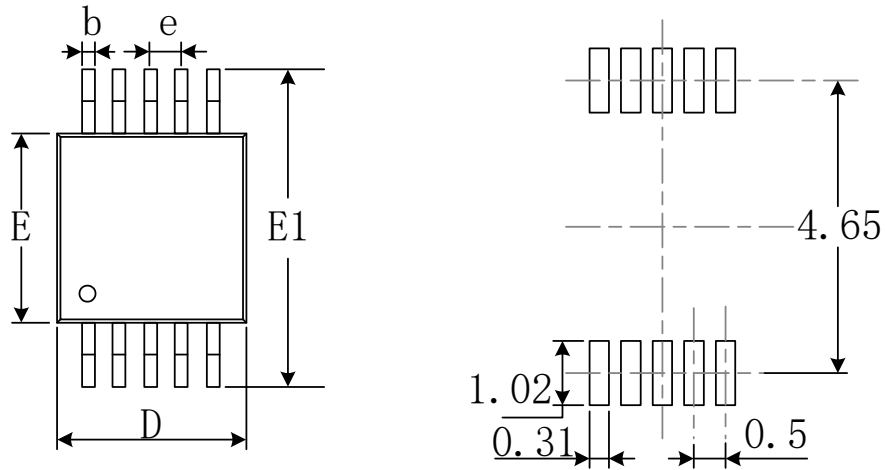

RECOMMENDED LAND PATTERN (Unit: mm)

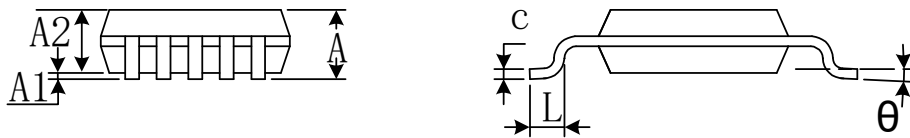

Symbol	Dimensions In Millimeters		Dimensions In Inches	
	Min	Max	Min	Max
A	0.820	1.100	0.032	0.043
A1	0.020	0.150	0.001	0.006
A2	0.750	0.950	0.030	0.037
b	0.180	0.280	0.007	0.011
c	0.090	0.230	0.004	0.009
D	2.900	3.100	0.114	0.122
e	0.50(BSC)		0.020(BSC)	
E	2.900	3.100	0.114	0.122
E1	4.750	5.050	0.187	0.199
L	0.400	0.800	0.016	0.031
θ	0°	6°	0°	6°

# TSSOP-14

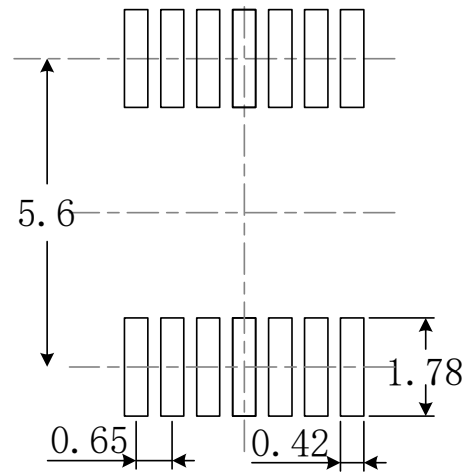
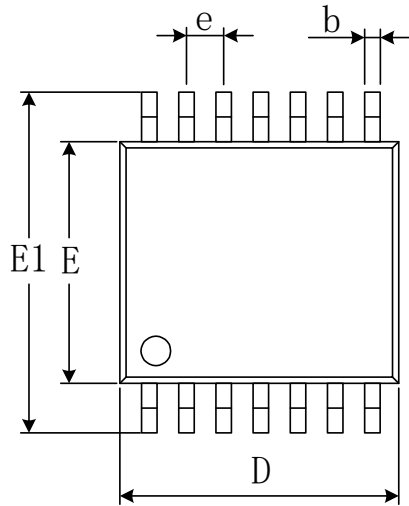

RECOMMENDED LAND PATTERN (Unit: mm)

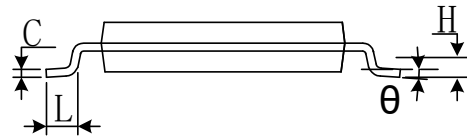
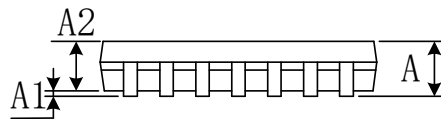

Symbol	Dimensions In Millimeters		Dimensions In Inches	
	Min	Max	Min	Max
A		1.200		0.047
A1	0.050	0.150	0.002	0.006
A2	0.800	1.050	0.031	0.041
b	0.190	0.300	0.007	0.012
c	0.090	0.200	0.004	0.008
D	4.860	5.100	0.191	0.201
E	4.300	4.500	0.169	0.177
E1	6.250	6.550	0.246	0.258
e	0.650(BSC)		0.026(BSC)	
L	0.500	0.700	0.020	0.028
H	0.25(TYP)		0.01(TYP)	
$\theta$	1°	7°	1°	7°

# SOIC-8(SOP8)

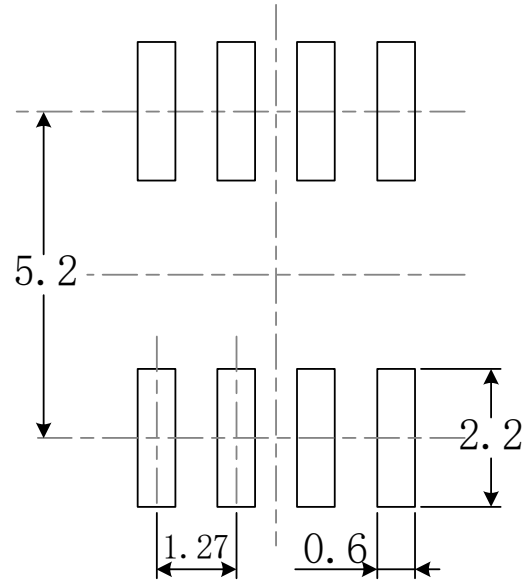
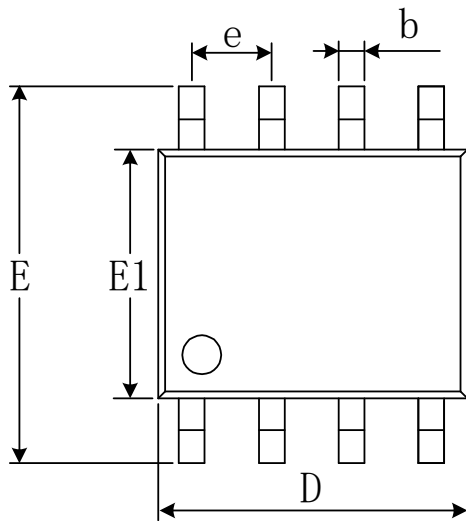

RECOMMENDED LAND PATTERN (Unit: mm)

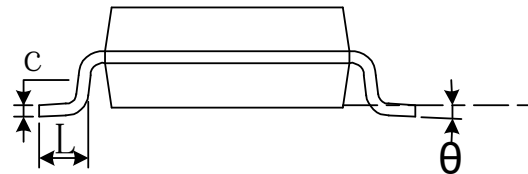
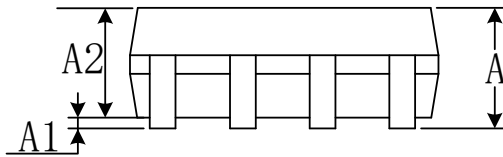

Symbol	Dimensions In Millimeters		Dimensions In Inches	
	Min	Max	Min	Max
A	1.350	1.750	0.053	0.069
A1	0.100	0.250	0.004	0.010
A2	1.350	1.550	0.053	0.061
b	0.330	0.510	0.013	0.020
c	0.170	0.250	0.007	0.010
D	4.800	5.000	0.189	0.197
e	1.270(BSC)		0.050(BSC)	
E	5.800	6.200	0.228	0.244
E1	3.800	4.000	0.150	0.157
L	0.400	1.270	0.016	0.050
$\theta$	0°	8°	0°	8°

# SOIC-14(SOP14)

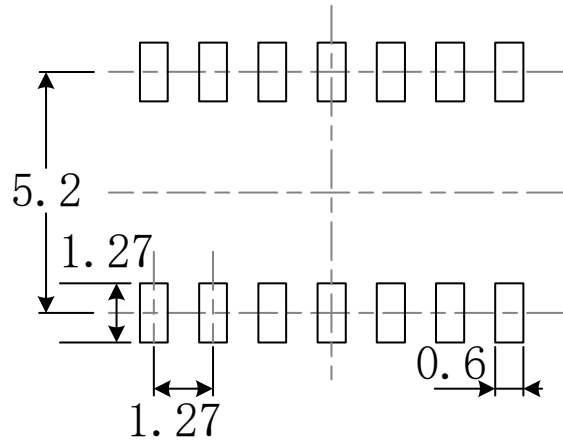
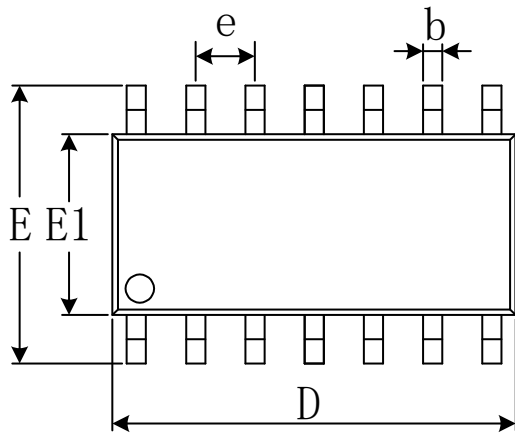

RECOMMENDED LAND PATTERN (Unit: mm)

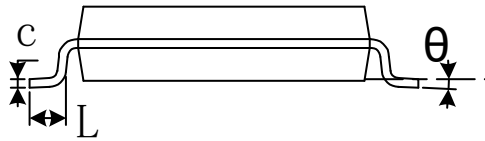
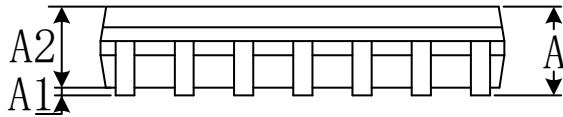

Symbol	Dimensions In Millimeters		Dimensions In Inches	
	Min	Max	Min	Max
A	1.350	1.750	0.053	0.069
A1	0.100	0.250	0.004	0.010
A2	1.350	1.550	0.053	0.061
b	0.310	0.510	0.012	0.020
c	0.100	0.250	0.004	0.010
D	8.450	8.850	0.333	0.348
e	1.270(BSC)		0.050(BSC)	
E	5.800	6.200	0.228	0.244
E1	3.800	4.000	0.150	0.157
L	0.400	1.270	0.016	0.050
$\theta$	0°	8°	0°	8°

# TDFN-2x2-8

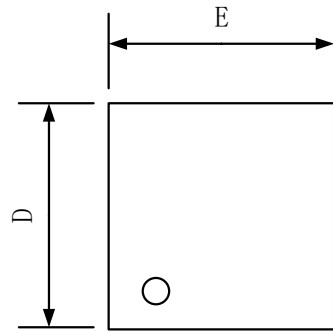

TOP VIEW

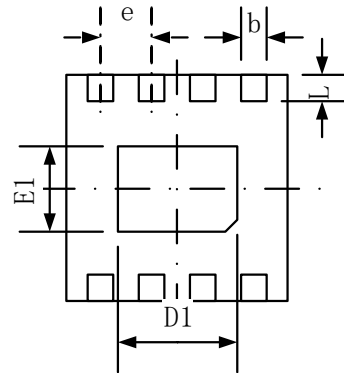

BOTTOM VIEW

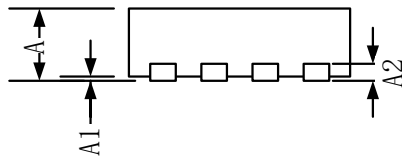

SIDE VIEW

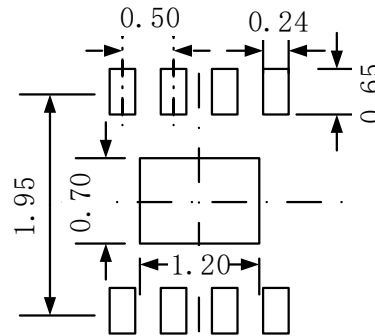

RECOMMENDED LAND  
PATTERN (Unit: mm)

Symbol	Dimensions In Millimeters		Dimensions In Inches	
	Min	Max	Min	Max
A	0.700	0.800	0.028	0.031
A1	0.000	0.050	0.000	0.002
A2	0.203(TYP)		0.008(TYP)	
b	0.180	0.300	0.007	0.012
D	1.900	2.100	0.075	0.083
D1	1.100	1.300	0.043	0.051
E	1.900	2.100	0.075	0.083
E1	0.600	0.800	0.024	0.031
e	0.500(TYP)		0.020(TYP)	
L	0.250	0.450	0.010	0.018

**全球销售及服务网点联系信息：**

**深圳市英锐恩科技有限公司**

ENROO-TECH (SHENZHEN) CO.,LTD

中国·深圳市龙岗区环城南路坂田国际中心C2栋8楼815

Enroo-Tech Technologies CO., Limited

香港新界葵涌工业街24-28号威信物流中心13楼A室

联系电话：86-755-82543411,83167411

联系传真：86-755-82543511

全国热线：4007-888-234

联系邮件：[enroo@enroo.com](mailto:enroo@enroo.com)

公司网站：<http://www.enroo.com>

企业官网二维码



企业公众号二维码

